



**BOSCH**



**Register** your  
new device on  
MyBosch now and  
get free benefits:  
**[bosch-home.com/  
welcome](https://www.bosch-home.com/welcome)**

# Gas hob

PBP6B....., PBH6B....., PBC6B.....

**[en]** Instruction manual

Gas hob

PBP6B.....

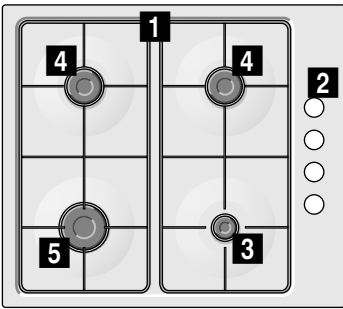

PBC6B.....

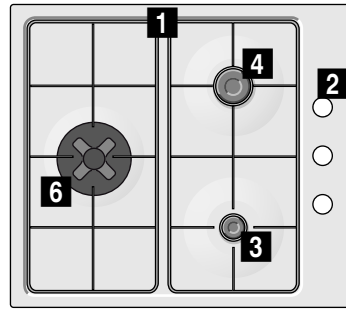

PBH6B.....

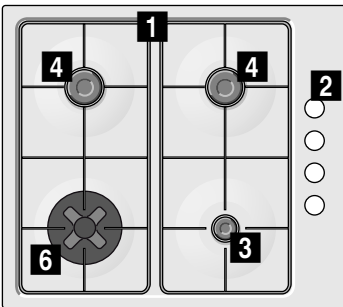

- 
- 1** Pan supports
  - 2** Control knobs
  - 3** Economy burner with an output of up to 1 kW
  - 4** Standard-output burner with an output of up to 1.75 kW
  - 5** High-output burner with an output of up to 3 kW
  - 6** Mini wok burner up to 3.3 kW

# Table of contents

|  |   |          |
|--|---|----------|
|    | <b>Intended use</b> . . . . .                   | <b>3</b> |
|    | <b>Important safety information</b> . . . . .   | <b>4</b> |
|    | <b>Getting to know your appliance</b> . . . . . | <b>5</b> |
|  | Accessories . . . . .                           | 5        |
|    | <b>Gas burners</b> . . . . .                    | <b>6</b> |
|  | Switching on manually . . . . .                 | 6        |
|  | Switching on automatically . . . . .            | 6        |
|  | Safety system . . . . .                         | 6        |
|  | Switching off a burner . . . . .                | 6        |
|  | Power levels . . . . .                          | 6        |
|  | Warnings . . . . .                              | 6        |
|  | Cooking guidelines . . . . .                    | 7        |
|    | <b>Cooking pans</b> . . . . .                   | <b>7</b> |
|  | Suitable pans . . . . .                         | 7        |
|  | Instructions for use . . . . .                  | 7        |
|    | <b>Cleaning and maintenance</b> . . . . .       | <b>8</b> |
|  | Cleaning . . . . .                              | 8        |
|  | Maintenance . . . . .                           | 8        |
|  | <b>Trouble shooting</b> . . . . .               | <b>8</b> |
|  | <b>Customer service</b> . . . . .               | <b>9</b> |
|  | Warranty conditions . . . . .                   | 9        |
|  | <b>Environmental protection</b> . . . . .       | <b>9</b> |
|  | Environmentally-friendly disposal . . . . .     | 9        |

Additional information on products, accessories, replacement parts and services can be found at **bosch** and in the online shop **banyo.co.uk**

## Intended use

Read these instructions carefully. You will only be able to use your appliance safely and effectively when you have read them. These operating and installation instructions should be retained, and passed onto the buyer if the appliance is sold.

**The manufacturer is exempt from all responsibility if the requirements of this manual are not complied with.**

The images shown in these instructions are for guidance only.

Do not remove the appliance from its protective packaging until it is installed in the unit. Do not switch on the appliance if it is damaged in any way. Contact our Technical Assistance Service.

This appliance is class 3 type, according to the EN 30-1-1 regulation for gas appliances: built-in appliance.

Before installing your new hob, ensure that it is being installed according to the installation instructions.

This appliance cannot be installed on yachts or in caravans.

This appliance must only be used in well ventilated places.

This appliance is not intended for operation with an external clock timer or a remote control.

**All operations relating to installation, connection, regulation and conversion to other gas types must be performed by an authorised technician, respecting all applicable regulations, standards and the specifications of the local gas and electricity suppliers. Special attention shall be paid to ventilation regulations.**

This appliance leaves the factory set to the gas type that is indicated on the specifications plate. If this needs to be changed, please consult the assembly instructions. It is recommended you contact the Technical Assistance Service to change to another gas type.

This appliance has been designed for home use only, not for commercial or professional use. This appliance is only intended for

cooking purposes, not as a heating system. The warranty will only be valid if the appliance is used for the purpose for which it was designed.

This appliance is intended for use up to a maximum height of 2000 metres above sea level.

Do not use lids or hob guards for children which are not recommended by the hob manufacturer. They may cause accidents such as those due to the overheating, ignition or detachment of fragments of materials.

This appliance may be used by children over the age of 8 years old and by persons with reduced physical, sensory or mental capabilities or by persons with a lack of experience or knowledge if they are supervised or are instructed by a person responsible for their safety how to use the appliance safely and have understood the associated hazards.

Children must not play with, on, or around the appliance. Children must not clean the appliance or carry out general maintenance unless they are at least 15 years old and are being supervised.

Keep children below the age of 8 years old at a safe distance from the appliance and power cable.

---

## Important safety information

### Warning – Risk of deflagration!

Accumulation of unburned gas in an enclosed area carries a risk of deflagration. Do not subject the appliance to draughts. These might blow out the burners. Carefully read the instructions and warnings on the operation of gas burners.

### Warning – Risk of poisoning!

The kitchen will become hot and humid and combustion products produced when this gas appliance is used. Make sure the kitchen is well ventilated, particularly when the hob is in operation: either keep the natural ventilation apertures open, or install a ventilation system (extractor hood). Intense prolonged use of the appliance may require additional or more effective ventilation: open a window or increase the power of the ventilation system.

### Warning – Risk of burns!

- The burners and their immediate vicinity get very hot. Never touch the hot surfaces. Keep children under 8 years old well away from this appliance.
- If the liquefied gas bottle is not upright, liquefied propane/butane can enter the appliance. Intense darting flames may therefore escape from the burners. Components may become damaged and start to leak over time so that gas escapes uncontrollably. Both can cause burns. Always use liquefied gas bottles in an upright position.

### Warning – Risk of fire!

- The cooking process must be supervised. A short cooking process must be supervised without interruption.
- The burners get very hot. Do not rest inflammable objects on the hob. Do not store objects on the hob.
- Do not store or use corrosive chemicals, products which produce fumes, inflammable materials or non-food products below or near this domestic appliance.
- Fat or oil which is overheated can catch fire easily. Never leave fat or oil to heat up unattended. If oil or fats do catch fire, never use water to put the fire out. Put the fire out by covering the pan with a lid and switch off the hotplate.

**⚠ Warning – Risk of injuries!**

- Pans which are damaged, are not the right size, hang over the edge of the hob or are not positioned correctly can cause serious injuries. Follow the advice and warnings provided relating to the cooking pans.
- Incorrect repairs are dangerous. Repairs may only be carried out, and damaged power and gas lines replaced, by an after-sales engineer trained by us. If the appliance is faulty, unplug the mains plug or switch off the fuse in the fuse box. Shut off the gas supply. Contact the after-sales service.
- If a control knob is too stiff to turn or it is loose, it must not be used. Contact our after-sales service immediately to have the control knob repaired or replaced.

**⚠ Warning – Risk of electric shock!**

Do not clean the appliance using steam cleaners.

## Getting to know your appliance

You can find your appliance and the burner powers in the model overview. → *Page 2*

### Accessories

The following accessories can be purchased from the Technical Assistance Service:

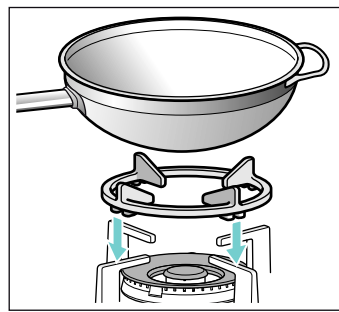
**Additional wok grid**

Only suitable for use on wok burners. Use cookware with a rounded base.

To extend the service life of the appliance, we recommend using the additional wok grid.

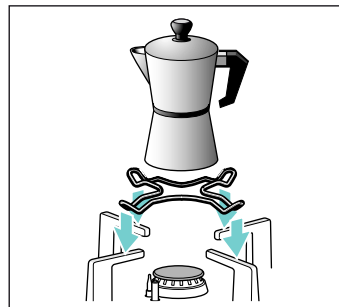
**Additional espresso maker grid**

Only suitable for use on the smallest burner. Use cookware with a diameter of less than 12 cm.

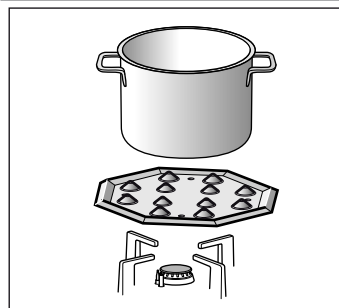
**Simmer plate**

This accessory part is only suitable for simmering. It can be used with the economy burner or the standard-output burner. If your hob has several standard-output burners, we recommend placing the simmer plate on the rear or front-right standard-output burner.

Place the accessory component with the projections facing upwards on the holder; never place it directly on the burner.

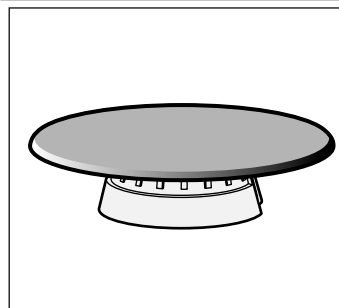
**Simmer cap**

Only use the burner for cooking with minimal power. Remove the economy burner and replace it with the simmer cap. Always place cookware on the pan support, never directly on the simmer cap.

**Code**

- HEZ298108 Additional wok grid: cast iron (3.3 kW)
- HEZ298110 Additional wok grid: Enamelled steel
- HEZ298114 Additional espresso maker grid
- HEZ298105 Simmer Plate
- HEZ298104 Simmer cap

The manufacturer accepts no liability if these accessories are not used or are used incorrectly.

## Gas burners

There are indications to show which burner each control knob operates.

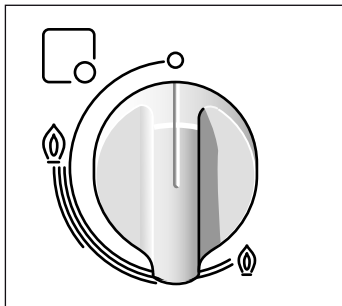

It is essential to ensure that all the burner parts and pan supports are correctly installed for the appliance to work correctly. Do not swap the burner caps around.

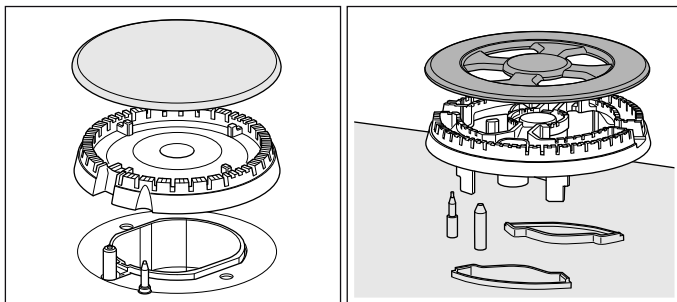

### Switching on manually

1. Press the chosen burner control knob and turn it anticlockwise to the required setting.
2. Use any type of lighter or flame (cigarette lighter, matches, etc.) and bring it close to the burner.

### Switching on automatically

If your hob can be switched on automatically (ignition sparkers):

1. Press the chosen burner control knob and turn it anticlockwise to the maximum power setting. While the control knob is still pressed down, sparks are produced on all burners. The flame ignites. Wait a few seconds.
2. Release the control knob.
3. Turn the control knob to the required setting.

If it does not come on, turn the control knob to the off setting and repeat the steps above. This time, press and hold the control knob for longer (up to 10 seconds).

### Warning – Risk of deflagration!

If after 15 seconds the flame does not ignite, switch off the burner and open a nearby window or door. Wait at least one minute before trying to switch the burner back on.

### Safety system

Your hob is equipped with a safety system (thermocouple) that cuts off the gas when the burners are accidentally switched off.

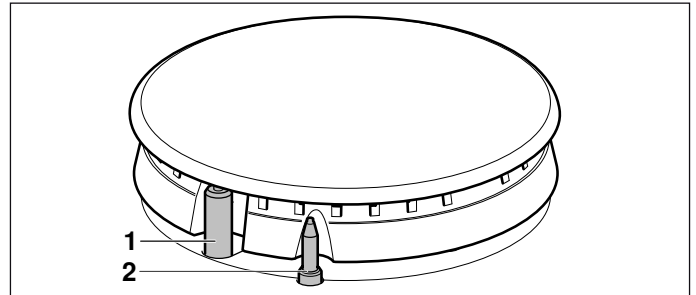

- 1 ignition sparker
- 2 thermocouple

To ensure that this device is active:



1. Switch on the burner as usual.
2. Without releasing the control knob, press and hold it down firmly for 4 seconds after lighting the flame.

### Switching off a burner

Turn the corresponding control knob clockwise to the 0 setting.

### Power levels

The progressive control knobs can be used to control the power needed, from minimum to maximum power.

|            |   |   |
|------------|---|---|
| Setting    |  | Control knob off                                |
| High flame |  | Maximum capacity or aperture and electricity on |
| Low flame  |  | Minimum capacity or aperture                    |

### Warnings

It is normal to hear a soft whistling noise while the burner is operating.

When first used, it is normal for the burner to give off odours. This does not pose any risk and does not indicate a malfunction. They will disappear in time.

An orange-coloured flame is normal. This is caused by the presence of dust in the atmosphere, spilt liquids, etc.

If the burner flames are accidentally blown out, switch off the burner operating control knob and do not try to relight it for at least 1 minute.

A few seconds after the burner is switched off, a sound (thud) will be produced. This is not a fault - this means that the safety device is no longer operating.

Keep the burner as clean as possible. If the ignition sparkers are dirty they will not light properly. Clean them periodically using a small non-wire brush. Bear in mind that the ignition sparkers must not suffer any serious impacts.

### Cooking guidelines

| Burner                 | Very high - High   | Medium   | Low                               |
|------------------------|--|--|-----------------------------------|
| Wok burner             | Boiling, steaming, griddling, toasting, paellas, Asian food (wok). | Reheating and keeping things hot: cooked and pre-cooked dishes     |                                   |
| High-output burner     | Escalopes, steaks, omelettes, frying                               | Rice, white sauce, ragout  | Steaming: fish, vegetables        |
| Standard-output burner | Steamed potatoes, fresh vegetables, vegetable stews, pasta         | Reheating, keeping things hot and making tasty casseroles          |                                   |
| Economy burner         | Cooking: casseroles, rice pudding, caramel                         | Defrosting and slow cooking: vegetables, fruit and frozen products | Melting: butter, chocolate, jelly |

## Cooking pans

### Suitable pans

| Burner                 | Minimum diameter of the cookware base | Maximum diameter of the cookware base |
|------------------------|---------------------------------------|---------------------------------------|
| Wok burner             | 22 cm                                 | 30 cm                                 |
| High-output burner     | 20 cm                                 | 26 cm                                 |
| Standard-output burner | 14 cm                                 | 22 cm                                 |
| Economy burner         | 12 cm                                 | 16 cm                                 |

The cookware must not overhang the edge of the hob.

### Instructions for use

**Note:** When using certain pots or pans, a slight and temporary deformation of the steel cooking surface may occur. This is normal and does not affect the functionality of the appliance.

The following recommendations can help you save energy and avoid damaging your cookware:

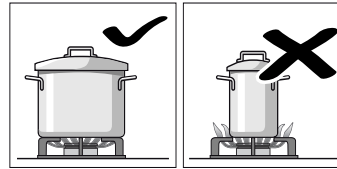

Use pans which are the right size for each burner. Do not use small pans on large burners. The flame must not touch the sides of the pan.

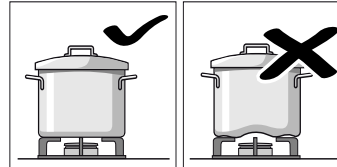

Do not use damaged pans, which do not sit evenly on the hob. Pans may tip over. Only use pans with a thick, flat base.

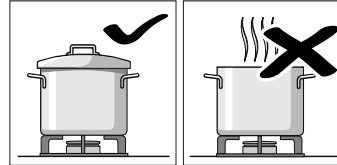

Do not cook without using a lid and make sure the lid is properly fitted. This wastes energy.

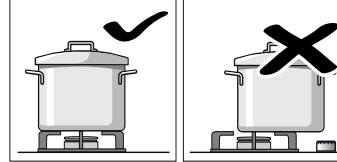

Always centre the pan over the burner, not to one side. Otherwise it could tip over. Do not place large pans on the burners near the control knobs. These may be damaged by the very high temperatures.

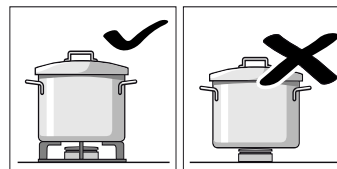

Place the pans on the pan supports, never directly on the burner. Make sure that the pan supports and burner caps are correctly positioned before using the appliance.

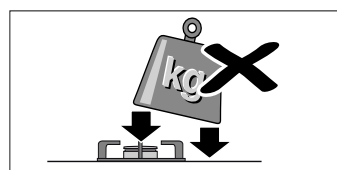

Pans should be placed on the hob carefully. Do not strike the hob and do not place excessive weight on it.



## Cleaning and maintenance

### Cleaning

Once the appliance is cool, use a sponge to clean it with soap and water.

After each use, clean the surface of the respective burner parts once they have cooled down. If any residue is left (baked-on food, drops of grease etc.), however little, it will become stuck to the surface and more difficult to remove later. The holes and grooves must be clean for the flame to ignite properly.

The movement of some pans may leave metal residue on the pan supports.

Clean the burners and pan supports using soapy water and scrub with a non-wire brush.

If the pan supports are fitted with rubber rests, ensure that these are also cleaned. The rests may come loose and the pan support may scratch the hob.

Always dry the burners and pan supports completely. Water droplets or damp patches on the hob at the start of cooking may damage the enamel.

After cleaning and drying the burners, make sure the burner caps are correctly positioned on the diffuser.

### Caution!

- Do not remove the control knobs when cleaning the appliance. The appliance may be damaged if moisture finds its way inside.
- Do not use steam cleaners. This could damage the hob.

### Maintenance

Always clean off any liquid as soon as it is spilt. This will prevent food remains from sticking to the hob surface and you will save yourself any unnecessary effort.

Due to the high temperatures endured, the wok burner and the stainless steel zones (grease drip tray, burner outline, etc.) can change colour. This is normal. After each use, clean these areas with a product that is suitable for stainless steel.

It is recommended that the cleaning product available from our Technical Assistance Service (code 311499) is used regularly.

### Caution!

The stainless steel cleaner must not be used in the area around the controls. The (printed) symbols may be wiped off.

Do not leave acidic liquids (e.g. lemon juice, vinegar, etc.) on the hob.

## Trouble shooting

Sometimes certain faults detected can be easily resolved. Before calling the Technical Assistance Service, bear in mind the following advice:

| Fault  | Possible cause  | Solution   |
|--|---|--|
| The general electrical system is malfunctioning.   | Defective fuse.   | Check the fuse in the main fuse box and change it if it is damaged.  |
|  | The automatic safety switch or circuit breaker has tripped.                                 | Check the main control panel to see if the automatic safety switch or circuit breaker has tripped.   |
| The automatic switching on function does not work. | There may be food or cleaning products stuck between the ignition sparkers and the burners. | The space between the ignition sparker and the burner must be clean.   |
|  | The burners are wet.  | Dry the burner caps carefully.   |
|  | The burner caps are not correctly positioned.   | Check that the burner caps are correctly positioned.   |
|  | The appliance is not earthed, is poorly connected or the earthing is faulty.                | Contact the installation technician.   |
| The burner flame is not uniform.                   | The burner components are not correctly positioned.   | Correctly place the parts on the appropriate burner.   |
|  | The grooves on the burner are dirty.  | Clean the grooves on the burner.   |
| The gas flow is not normal or there is no gas.     | The gas supply is blocked by gas taps.  | Open all gas taps.   |
|  | If the gas is supplied from a gas cylinder, check that it is not empty.                     | Change the gas cylinder.   |
| The kitchen smells of gas.                         | A gas tap has been left on.   | Turn off the taps.   |
|  | Incorrect coupling of gas cylinder.   | Check that the coupling is sound.  |
|  | Possible gas leak.  | Shut off the gas supply, ventilate the premises and immediately notify an authorised installation technician to check and certify the installation. Do not use the appliance until ensuring that there is no gas leak in the installation or appliance itself. |



| Fault   | Possible cause                                      | Solution  |
|---|---|---|
| The burner immediately switches off after releasing the control knob. | The control knob was not held down for long enough. | Once the burner is on, hold the control knob down a few seconds longer. |
|   | The grooves on the burner are dirty.                | Clean the grooves on the burner.  |

## Customer service

When contacting our customer service, please provide the product number (E-Nr.) and production number (FD) of the appliance. This information is given on the specifications plate located on the lower section of the hob and on the label in the user manual.

Please find the contact data of all countries in the enclosed customer service list.

### To book an engineer visit and product advice

**GB** 0344 892 8979

Calls charged at local or mobile rate.

**IE** 01450 2655

0.03 € per minute at peak. Off peak 0.0088 € per minute.

Rely on the professionalism of the manufacturer. You can therefore be sure that the repair is carried out by trained service technicians who carry original spare parts for your appliances.

## Warranty conditions

In the unlikely event that the appliance is damaged or does not meet your expectations in terms of quality, please inform us as soon as possible. For the warranty to be valid, the appliance must not have been tampered with, or used inappropriately.

The applicable warranty conditions are those set out by the company's representative office in the country of purchase. Detailed information is available from retail outlets. Proof of purchase must be presented to obtain the benefits of the warranty.

We reserve the right to introduce changes.

## Environmental protection

If the  symbol is shown on the specifications plate, bear in mind the following instructions:

### Environmentally-friendly disposal

Dispose of packaging in an environmentally-friendly manner.



This appliance is labelled in accordance with European Directive 2012/19/EU concerning used electrical and electronic appliances (waste electrical and electronic equipment - WEEE). The guideline determines the framework for the return and recycling of used appliances as applicable throughout the EU.

The packaging of your appliance has been manufactured using only the materials which are strictly necessary to guarantee efficient protection during transport. These materials are 100% recyclable, thus reducing the environmental impact. You can also contribute to caring for the environment by following the advice below:

- Dispose of the packaging in the appropriate recycling bin.
- Before you get rid of an old appliance, make sure you disable it. Contact your local authority to find out the address of your nearest recycling centre to dispose of your appliance.
- Do not pour used oil down the sink. Collect it in a sealed container and take it to an appropriate collection point or, failing that, place it in the rubbish bin (it will end up in a controlled dump; this is probably not the best option, but it will avoid contaminating ground water).







## Thank you for buying a Bosch Home Appliance!

Register your new device on MyBosch now and profit directly from:

- **Expert tips & tricks for your appliance**
- **Warranty extension options**
- **Discounts for accessories & spare-parts**
- **Digital manual and all appliance data at hand**
- **Easy access to Bosch Home Appliances Service**

Free and easy registration – also on mobile phones:

**[www.bosch-home.com/welcome](http://www.bosch-home.com/welcome)**



## Looking for help? You 'll find it here.

Expert advice for your Bosch home appliances, need help with problems or a repair from Bosch experts.

Find out everything about the many ways Bosch can support you:

**[www.bosch-home.com/service](http://www.bosch-home.com/service)**

**Contact data of all countries are listed in the attached service directory.**

**Robert Bosch Hausgeräte GmbH**

Carl-Wery-Straße 34

81739 München

Germany

**[www.bosch-home.com](http://www.bosch-home.com)**



9001044285

990305(F)